

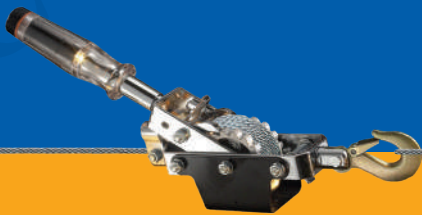

CONSTANTLY REFINING PRODUCTS



HAND POWER PULLER



至光工具股份有限公司
J&K International Co., Ltd.
Jun Kaung Industries Co., Ltd.

台灣台中市大里區景庄街180巷20號
Factory: 20, Lane 180, Jing Juang St., Tali, Taichung
Taiwan 412
Tel:886-4-24962255 Fax:886-4-24969265
e-mail: jk@jktool.com.tw
www.autoaccessory.com.tw
www.jktool.com.tw





As hand tools, they are second to none in the world.

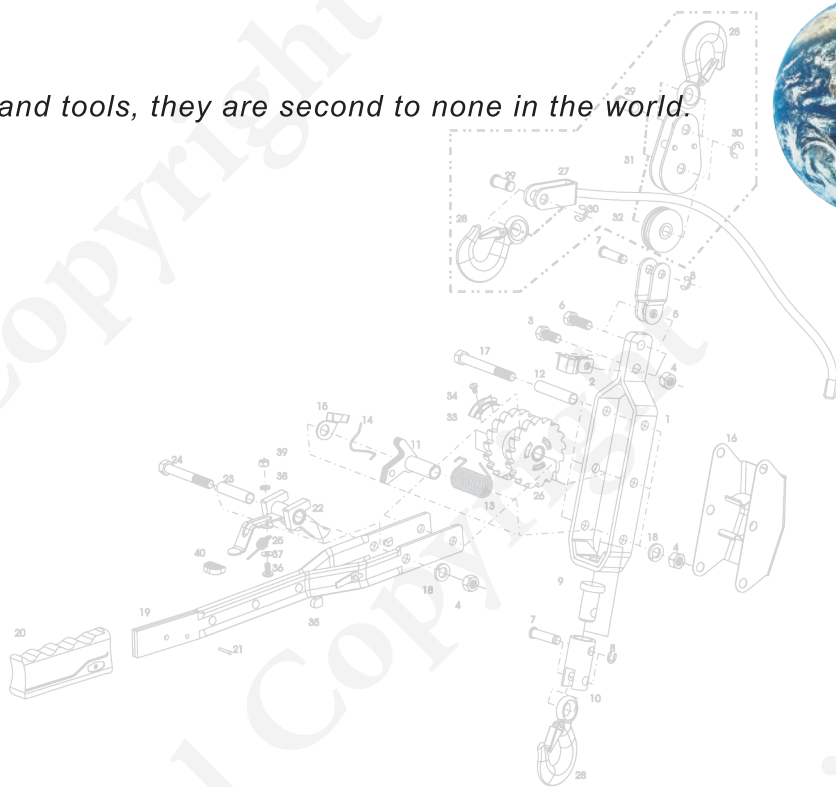



Welcome to **Jun Kaung**[®] world ...
MANUFACTURER

Our products are marketed worldwide.



Collection

● **Hand Power Puller**



○ Winch & Jack



○ Electricians Tool



○ Tie Down & Accessory



About JK



Hardness Tester

Since 1985, when JK first Hand Power Puller was manufactured in Taiwan, quality has been an integral part of all the products that bear JK name.

JK operates one operations center in Taiwan. The headquarters located in Taichung markets and finances global business and manages brand worldwide.



Puller Fatigue Tester

Market-Oriented Strategic Planning

JK develops the board marketing objectives and strategy based on an analysis of the current marketing situation and opportunities. JK Group is a market-oriented corporation, which enables it to remain at the forefront of the markets in auto industry.



Salt Spray (Fog) Testing Machine

JK means a high-performance mark that consistently satisfies or exceeds the expectation of consumers.



4T Testing Machine

JK pioneers both the research and the development fields of manufacturing hand tools that have become the essential elements in auto industries.

Not only does JK satisfy its customers' requirements, but also it consults for the interests of its customers.



Tie Down Fatigue Tester

JK is an established and rapidly growing supplier of hand tool products to auto industry. Its offerings include hand power puller, tie down, trailer winch, trailer jack, tie down buckle, web sling, luggage cord, cargo net, hook, and related auto accessories.



20T Micro-computer Universal Testing Machine

One-Stop Shop and Total Solution

"Listening to the customers" is an essential feature of our quality service initiative.

To pursue enhanced quality efforts including improved production procedures, innovative research and development, and best service.

Our customer service team responds the questions and complaints within 24 hours.



Funtion Testing Machine

We continually look for ways to improve quality. Our quality system as well as our products is established and developed with international standards.

We commit to research a dedicated product development and application program, designed to provide value-added services to our customers.

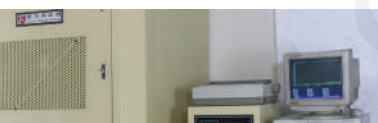

Torsion Testing Machine

A partnership with customers enhances their ability to edge competition by getting to market faster and more economically.



Winch Testing Machine



HAND POWER PULLER

With safety ever the first priority, industrial operators the world over know that JK spells rugged dependability in even the highest risk environments. Where the margin for error is zero there you will find J&K International Co., Ltd. providing the anchor point in an unpredictable world.

HAND POWER PULLER



J&K Hand Power Pullers are suitable for moving vehicles, boats, logs, machines and other heavy objects. All models are fitted with ratchet safety devices. Trouble-free thumb control release for maximum safety powerful ratcheting systems while pulling heavy duty load. It is perfect for all your demanding pulling applications, fencing, landscaping and moving heavy equipment. Be it emergency, recreational, agricultural or industrial, J&K Hand Power Pullers can do it all.



Strong, durable and easy to operate



HP-111



HP-160D

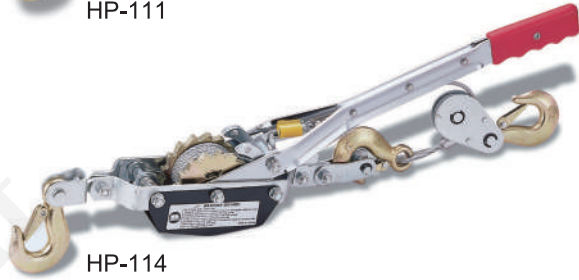

HP-114

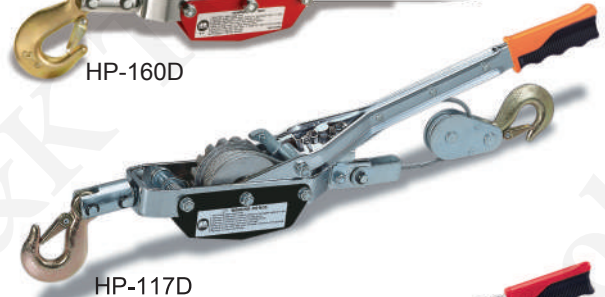

HP-117D

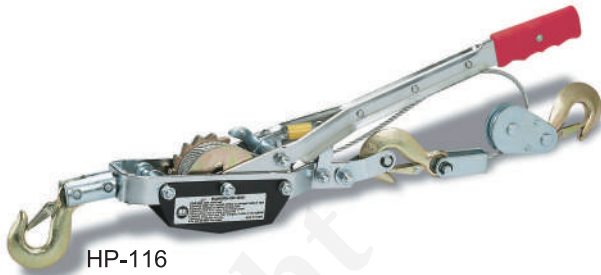

HP-116

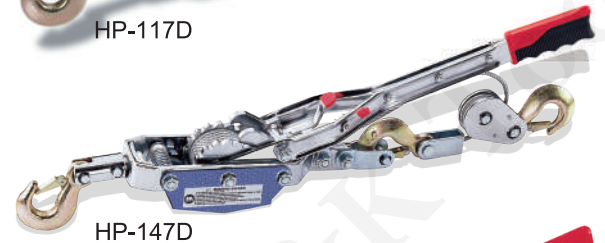

HP-147D

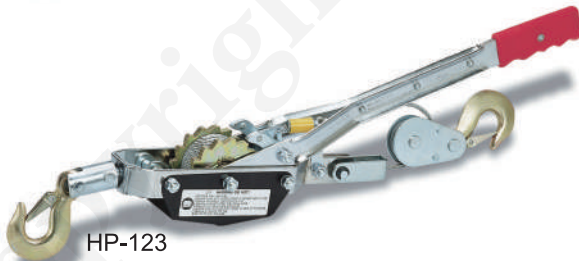

HP-123

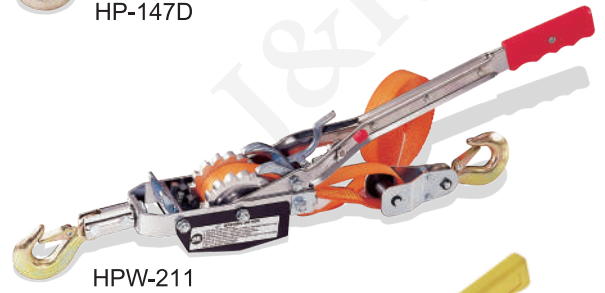

HPW-211

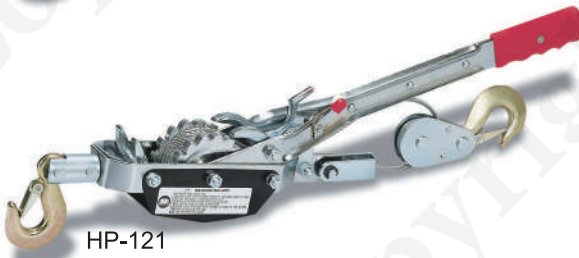

HP-121



HPR-301

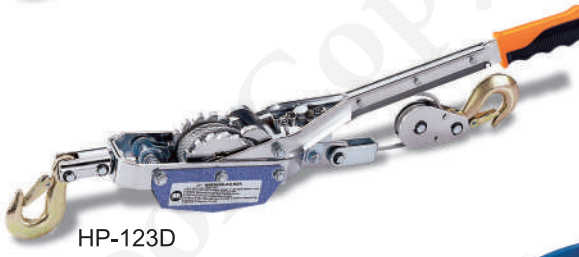

HP-123D



HPR-302



HP-134



HP-101P

HAND POWER PULLER

JUN KAUNG INDUSTRIES CO., LTD.

TEST REPORT

ADD:20, Lane 180, Jing Juang ST., Tali, Taichung, Taiwan

TEL :04-24962255

FAX :04-24969265

試件類別 : HP-406

LOT No. : 940322003

試件來源 : H-51

DATE : 03/23/2005

TEST SPEED 20

No	Specimen	Max Force (kgf)	Break Force (kgf)	Tensile Strength (kgf/mm ²)	Elongation (mm)	Elongation Rate (%)
1	HP-406	6136	6136	6136	4.67	9.34
2	HP-406	6120	6120	6120	5.27	10.54
3	HP-406	6096	6096	6096	4.8	9.6
4	HP-406	6100	6100	6100	4.67	9.34
5	HP-406	6126	6126	6126	5.3	10.6

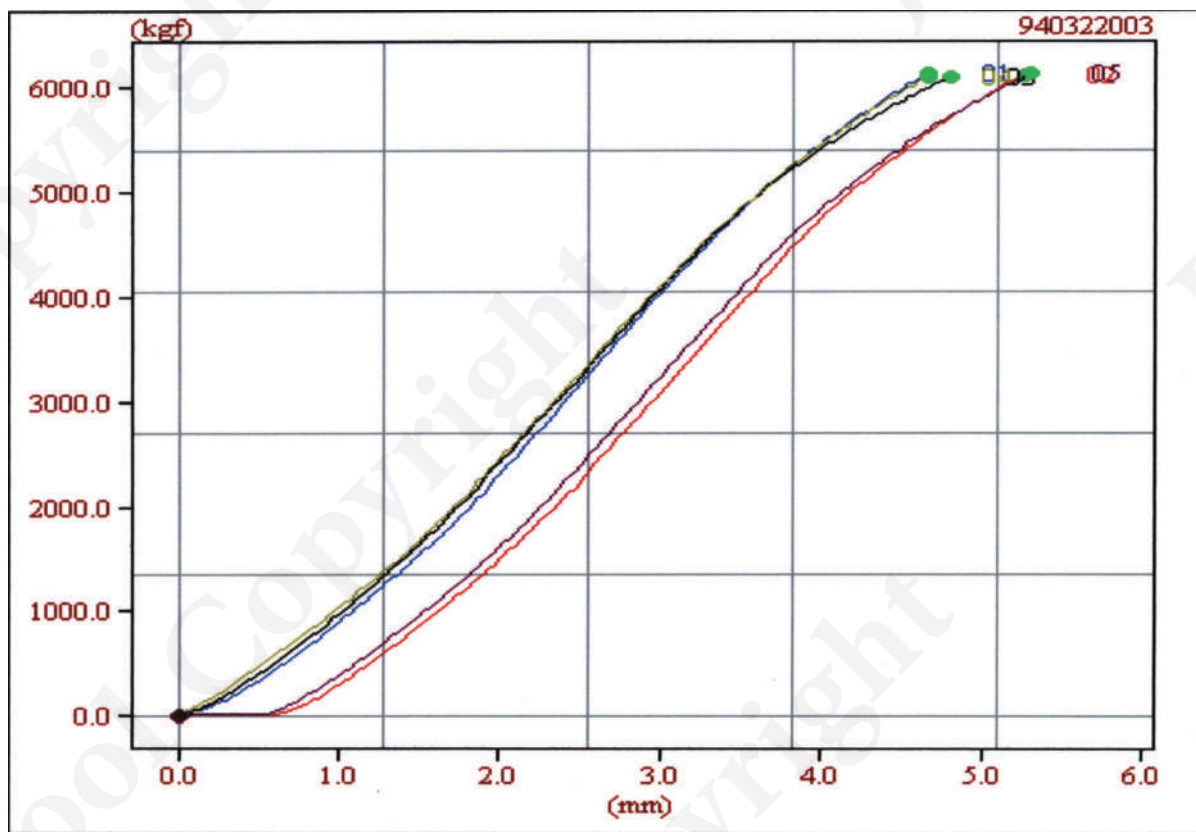

MANAGER :

TESTER :

HOW TO OPERATE HAND POWER PULLER

*Our quality,
your security guard*

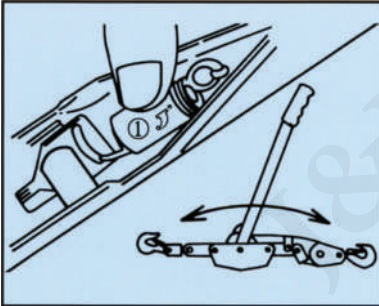

(1) TO RAISE LOAD OR APPLY TENSION

Push down yellow pawl spring (1) to engage Drive Pawl and Ratchet Wheel. Each stroke of handle will wind cable to pull load.

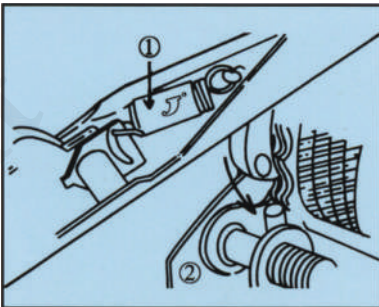

(2) TO RELEASE PULLER

Pull up yellow Pawl Spring (1) Steadily push handle until Drive Pawl pushes and disengages Stop Pawl in the direction of arrow at (2) to clear Ratchet Tooth. This releases load one notch. Repeat this handle motion as required to release tension at a time.

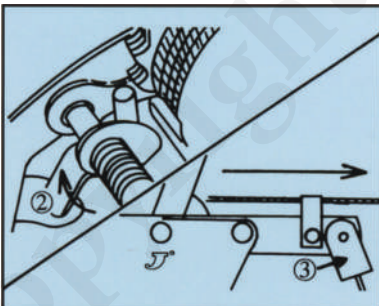

(3) TO EXTEND CABLE

Pull up Stop Pawl in the direction of arrow at (2) and at the same time pull Cable until desired slack is obtained.

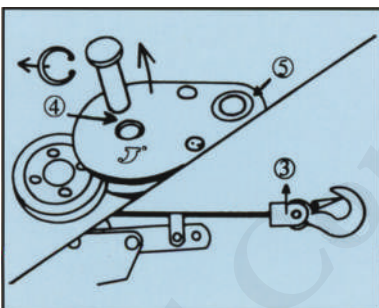

(4) SINGLE LINE OPERATION INSTRUCTION

Take off E-ring from Cable Rack (3) and from Pin (4) & (5) to un-assemble them all. Insert Cable Lead Stopper into Cable Rack (3) and fix Hook & Cable Rack (3) by Pin with E-ring

CAUTION: While puller is in single line status, the permitted capacity is half of that shown on the handle.

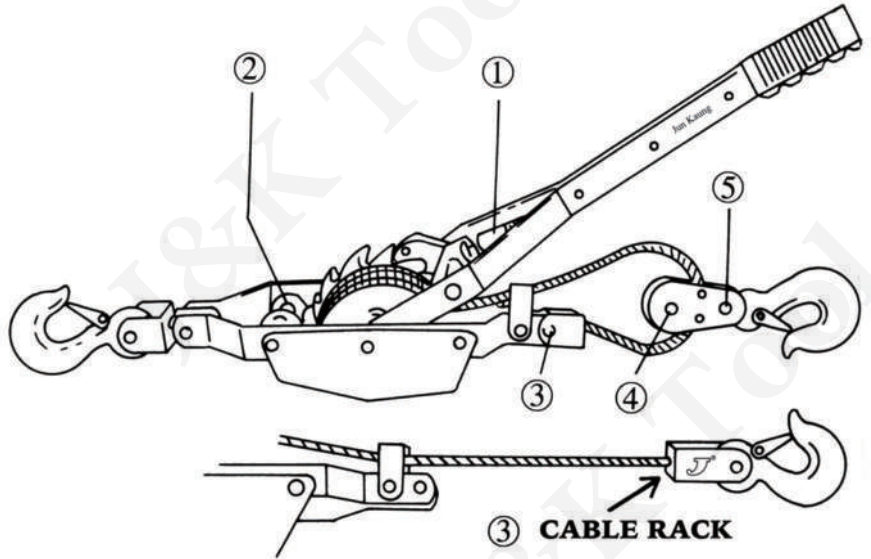

CAUTION: Make sure your Hand Power Puller is maintained in safe and proper working condition by observing the following rules:

1. Inspect cable regularly to examine the frays, kinks, broken strands or distortion. The cable should be replaced once one of above situation has occurred.
2. Do not pull cable over or around a corner.
3. Do not weap cable around any object and hook it back on itself.
4. Do not overload; know how much load is allowed when you are pulling.
5. Do not use a "cheater" pipe or other device to lengthen the handle for additional leverage. This will destroy the puller itself.
6. Do not operate puller with less than 3 wraps of cable on the spindle.
7. Please do use an adequate sling, eyebolt or other accessory attached to the load to be pulled. And make sure that there is positive engagement of the puller hook to the load.

CABLE REPLACEMENT

A "Keyhole" opening of special quick-change design in the barrel of the ratchet wheel and a swayed end to the cable permit instant, secure replacement of the cable, Pull all the cable off the ratchet wheel, snap old cable out of "keyhole", snap in new cable, and then rewind cable on ratchet wheel.

DIY



Durable



Safety



Precision



Bi-color Handle

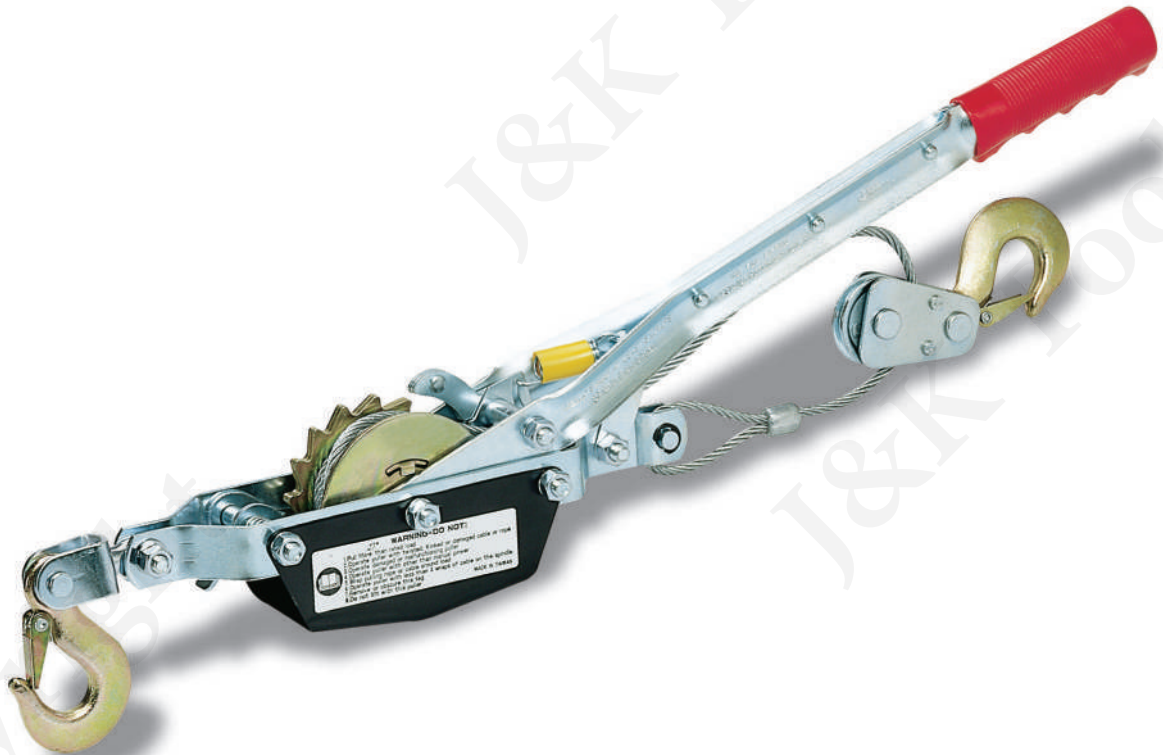

A compact and versatile tool

Polished heavy steel ratchet arm for a smooth nonbinding operation

Heat treated bolts

Drop forged steel hooks with spring safe latches

Mini Type Single Gear & Single Pawl

ITEM	CAPACITY	CABLE	HOOK	Thickness		PACKING			
				Handle	Body	N.W. (KG)	G.W. (KG)	CUFT	Q'TY
HP-100	3/4 TON	4mm x 7ft	2	2.3mm	2.3mm	12	14	1.1	6
HP-111	1 TON	5mm x 10ft	2	2.6mm	2.6mm	15	17	1.45	6
HP-112	1½ TON	5mm x 12ft	2	3.2mm	3mm	18	20	1.45	6

Package : 1pc / color box

DIY



Durable



Safety



Precision

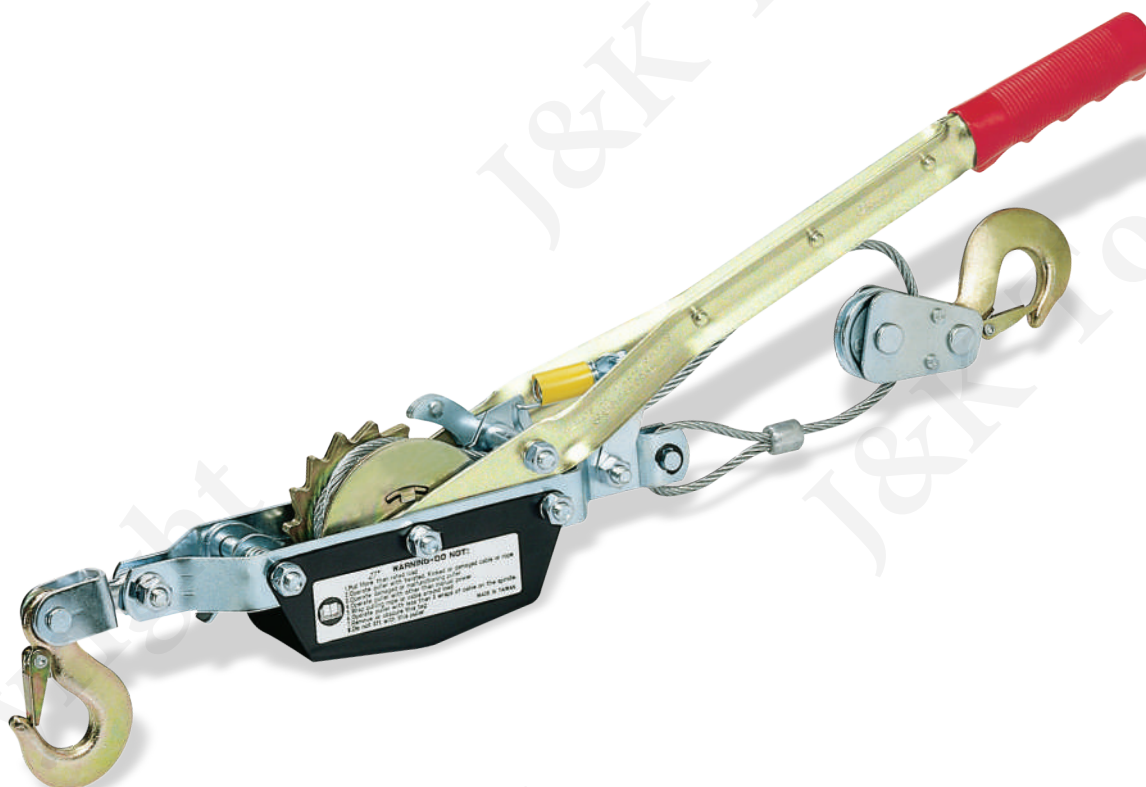

HAND POWER PULLER

A compact and versatile tool

Polished heavy steel ratchet arm for a smooth nonbinding operation

Heat treated bolts

Drop forged steel hooks with spring safe latches

Mini Type Single Gear & Single Pawl

ITEM	CAPACITY	CABLE	HOOK	Thickness		PACKING			
				Handle	Body	N.W. (KG)	G.W. (KG)	CUFT	Q'TY
HP-110	1 TON	4mm x 7ft	2	2.3mm	2.3mm	12	14	1.1	6

Package : 1pc / color box

DIY



Durable



Safety



Precision



HAND POWER PULLER

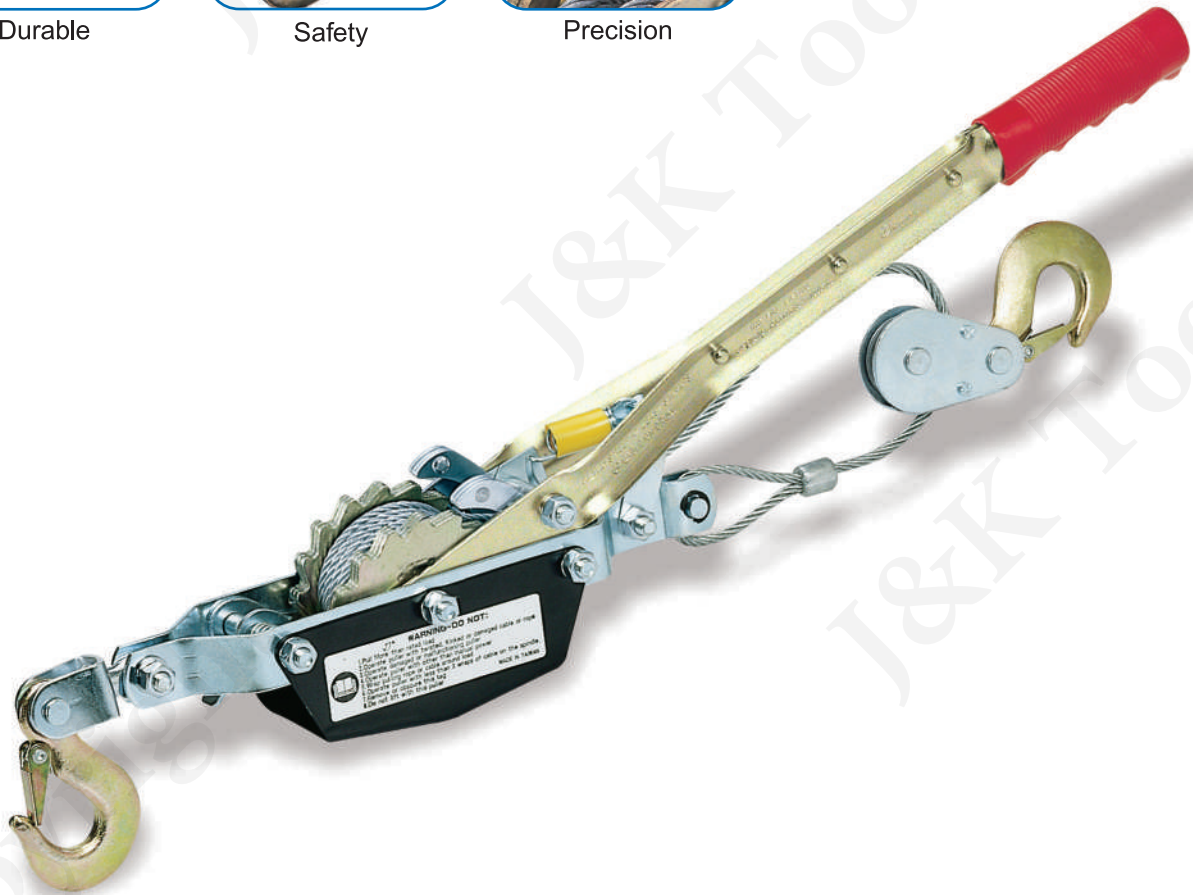

A compact and versatile tool

Polished heavy steel ratchet arm for a smooth nonbinding operation

Heat treated bolts

Drop forged steel hooks with spring safe latches

Mini Type Double Gear & Double Pawl

ITEM	CAPACITY	CABLE	HOOK	Thickness		PACKING			
				Handle	Body	N.W. (KG)	G.W. (KG)	CUFT	QTY
HP-102	2 TON	5mm x 7ft	2	2.8mm	2.6mm	15	16	1.1	6
HP-113	2 TON	5mm x 10ft	2	3.0mm	2.8mm	18	19	1.45	6

Package : 1pc / color box

DIY



Durable



Safety



Precision



HAND POWER PULLER

A compact and versatile tool

Polished heavy steel ratchet arm for a smooth nonbinding operation

Heat treated bolts

Drop forged steel hooks with spring safe latches

Mini Type Double Gear & Double Pawl

ITEM	CAPACITY	CABLE	HOOK	Thickness		PACKING			
				Handle	Body	N.W. (KG)	G.W. (KG)	CUFT	Q'TY
HP-114	2 TON	5mm x 10ft	3	3.5mm	3.5mm	24	26	1.45	6

Package : 1pc / color box

Standard



Strengthened



Precision



Solidness

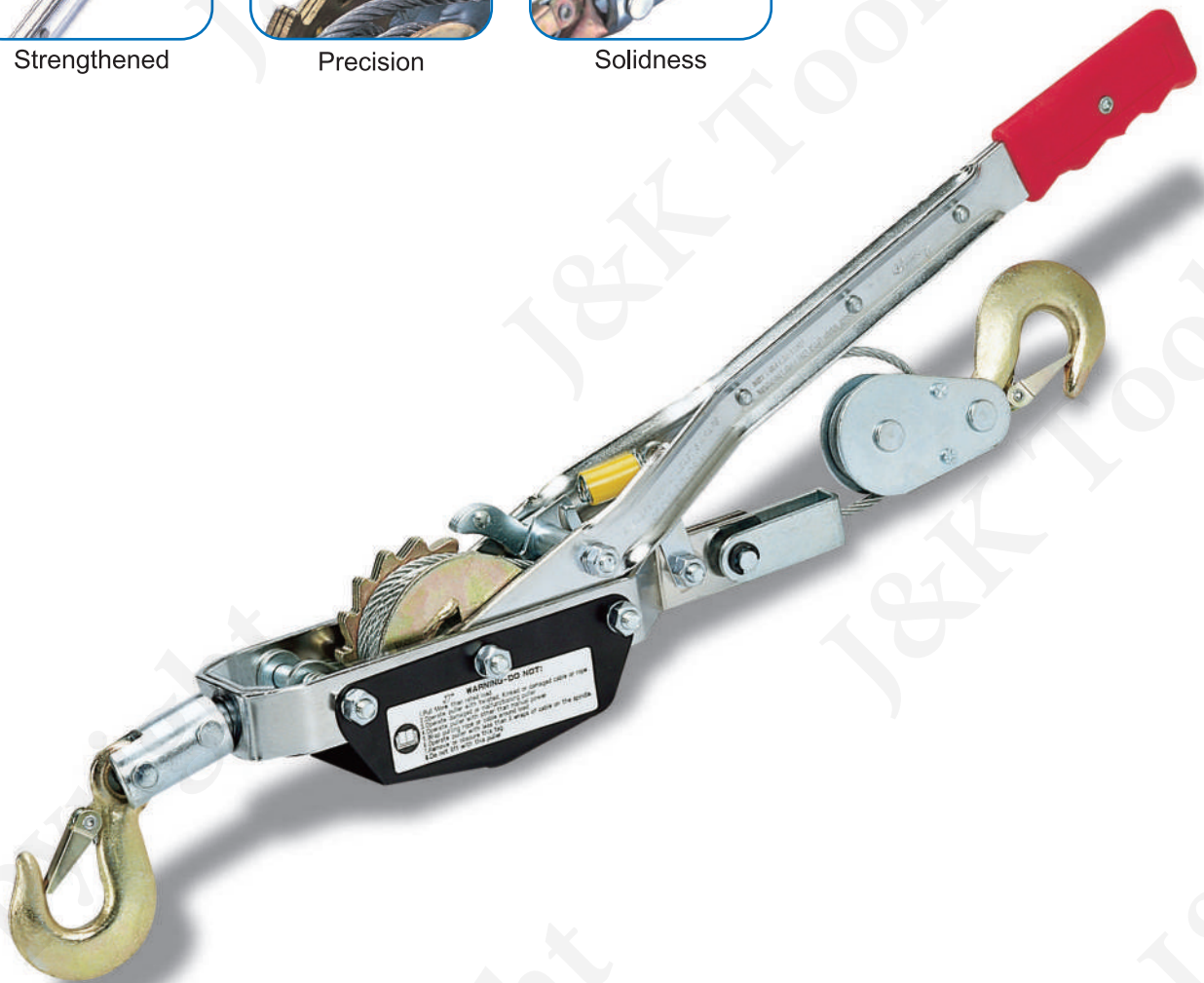

A great helpmate for your life and work

Comfortable hand grip

Heavy duty steel stamped ratchet gears, drive pawls and stop pawls for reinforcement

Heat treated bolts

Drop forged hanging bracket can be operated by 360 degrees

AI Type Single Gear & Single Pawl

ITEM	CAPACITY	CABLE	HOOK	Thickness		PACKING			
				Handle	Body	N.W. (KG)	G.W. (KG)	CUFT	Q'TY
HP-117	2 TON	5mm x 12ft	2	3.5mm	3.5mm	21.5	23.5	1.45	6
HP-132	3 TON	5mm x 12ft	2	4mm	4.5mm	25	27	1.75	6

Package : 1pc / color box

Standard



Strengthened



Precision



Solidness

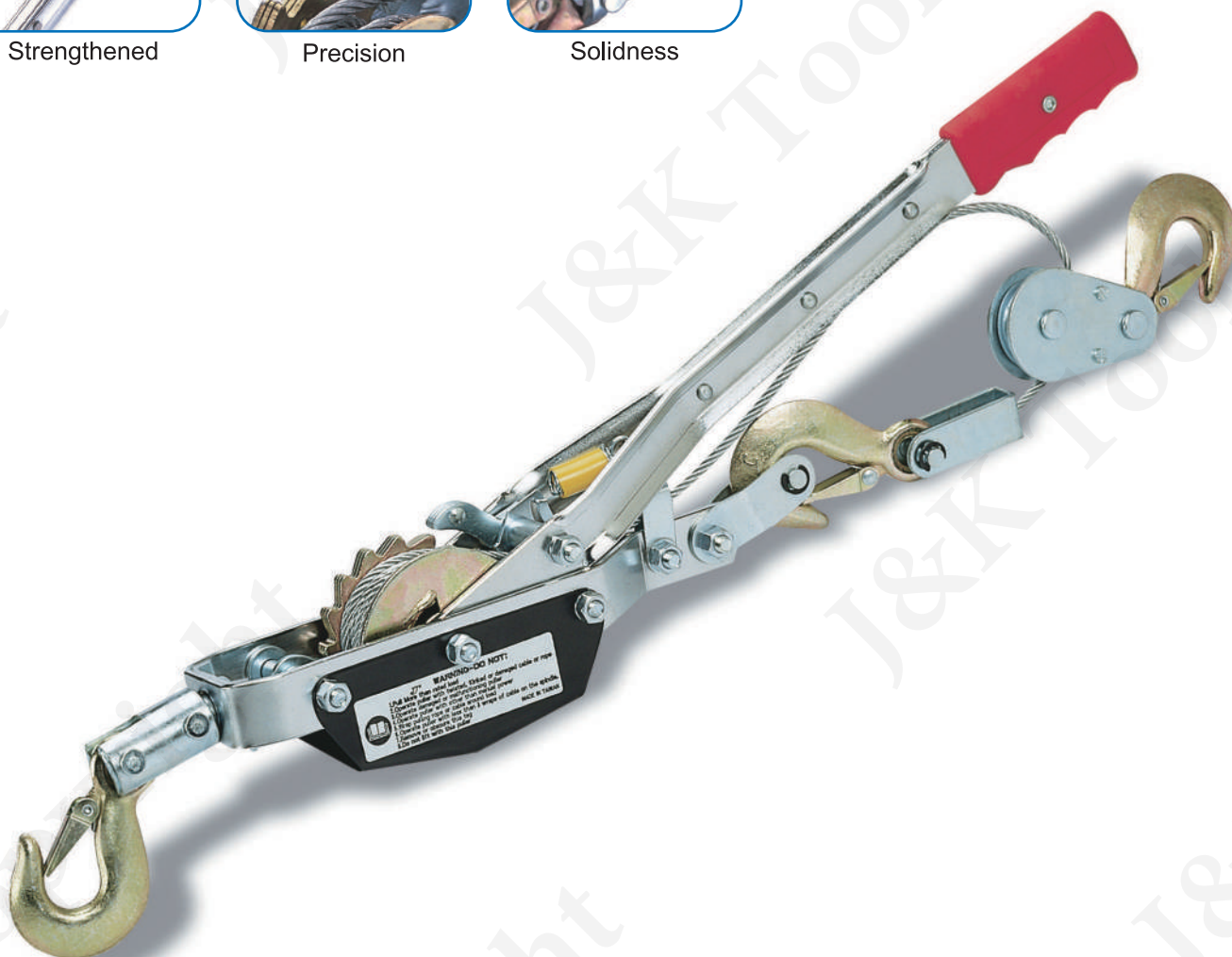

HAND POWER PULLER

A great helpmate for your life and work

Comfortable hand grip

Heavy duty steel stamped ratchet gears, drive pawls and stop pawls for reinforcement

Heat treated bolts

Drop forged hanging bracket can be operated by 360 degrees

AI Type Single Gear & Single Pawl

ITEM	CAPACITY	CABLE	HOOK	Thickness		PACKING			
				Handle	Body	N.W. (KG)	G.W. (KG)	CUFT	Q'TY
HP-133	3 TON	5mm x 12ft	3	4mm	4.5mm	27	29	1.75	6

Package : 1pc / color box

Standard



Strengthened



Solidness



Equilibrium

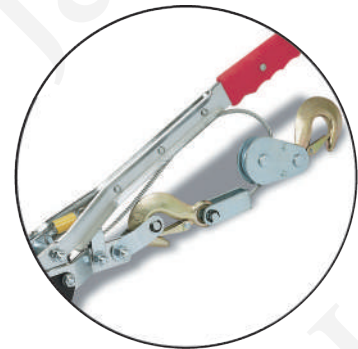
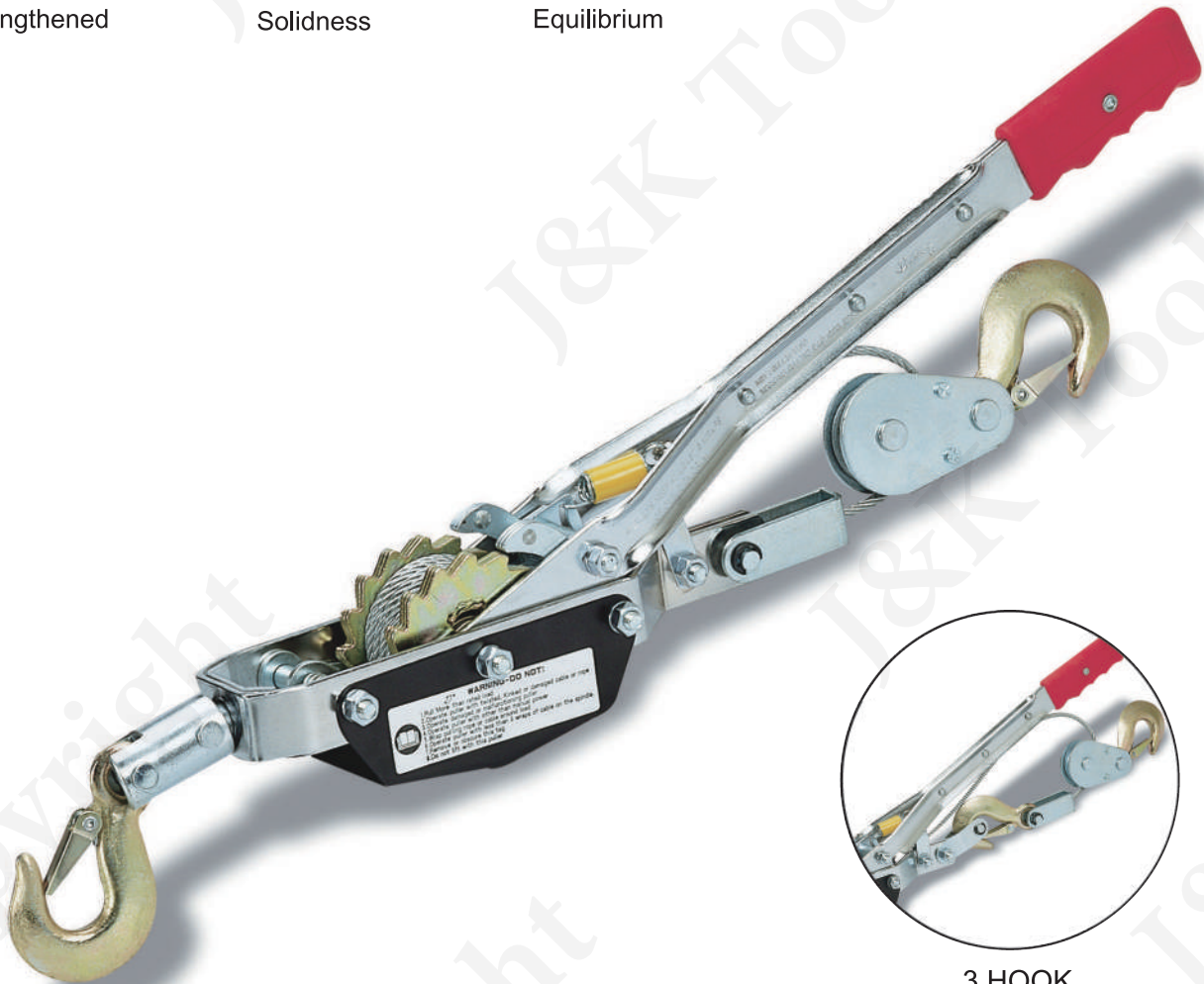

3 HOOK

A great helpmate for your life and work

Comfortable hand grip

Heavy duty steel stamped ratchet gears, drive pawls and stop pawls for reinforcement

Heat treated bolts

Double gears for equilibrium

Drop forged hanging bracket can be operated by 360 degrees

AI Type Double Gear & Double Pawl

ITEM	CAPACITY	CABLE	HOOK	Thickness		PACKING			
				Handle	Body	N.W. (KG)	G.W. (KG)	CUFT	Q'TY
HP-123	2 TON	5mm x 10ft	2	3.5mm	3.5mm	22	24	1.45	6
HP-124	2 TON	5mm x 10ft	3	3.5mm	3.5mm	24	26	1.45	6

Package : 1pc / color box

Standard

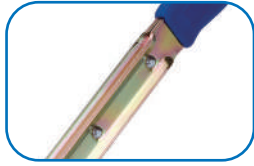

Strengthened



Precision



Solidness



HAND POWER PULLER

A great helpmate for your life and work

Comfortable hand grip

Heavy duty steel stamped ratchet gears, drive pawls and stop pawls for reinforcement

Heat treated bolts

Drop forged hanging bracket can be operated by 360 degrees

AI Type Double Gear & Double Pawl

ITEM	CAPACITY	CABLE	HOOK	Thickness		PACKING			
				Handle	Body	N.W. (KG)	G.W. (KG)	CUFT	Q'TY
HP-131	3 TON	5mm x 10ft	2	3.5mm	4.0mm	26	27	1.75	6

Package : 1pc / color box

Standard



Strengthened



Precision



Solidness



HAND POWER PULLER

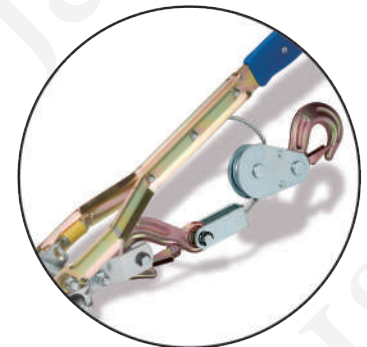

3 HOOK

A great helpmate for your life and work

Comfortable hand grip

Heavy duty steel stamped ratchet gears, drive pawls and stop pawls for reinforcement

Heat treated bolts

Drop forged hanging bracket can be operated by 360 degrees

AI Type Single Gear & Single Pawl

ITEM	CAPACITY	CABLE	HOOK	Thickness		PACKING			
				Handle	Body	N.W. (KG)	G.W. (KG)	CUFT	Q'TY
HP-134	4 TON	6mm x 10ft	2	4.0mm	4.0mm	21.5	22.5	1.8	4
HP-135	4 TON	6mm x 10ft	3	4.0mm	4.0mm	22.5	23.5	1.9	4

Package : 1pc / color box

Standard



Equilibrium



Safety



Solidness

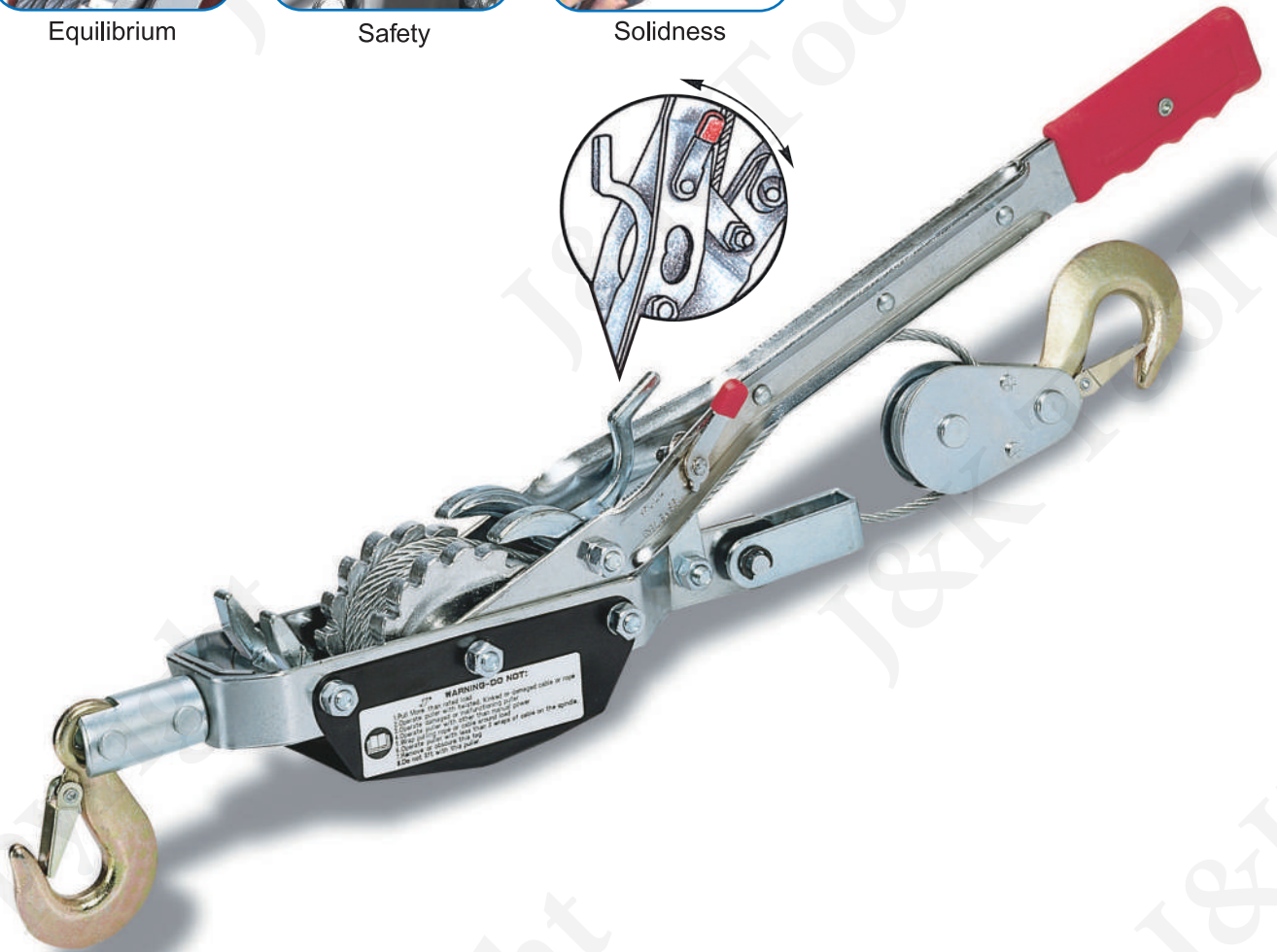

HAND POWER PULLER

A great helpmate for your life and work

- Comfortable hand grip
- Aluminum alloy gears for wear resistance
- Heat treated bolts
- Double gears for equilibrium
- Drop forged hanging bracket can be operated by 360 degrees

AI Type with Switch Double Gear & Double Pawl

ITEM	CAPACITY	CABLE	HOOK	Thickness		PACKING			
				Handle	Body	N.W. (KG)	G.W. (KG)	CUFT	Q'TY
HP-121	2 TON	5mm x 10ft	2	3.5mm	3.5mm	22.8	23.8	1.75	6

Package : 1pc / color box

Professional



Easy Operation



Safety



Durable



DURABLE SOLID STEEL GEAR



TYPE : HP-148D



3 HOOK

Strong, durable and easy operation

Durable solid steel gear construction for greater pulling power & safety

Large drop forged alloy steel safety hooks

Attractive bi-colored grip

Cable clamp fixed onto the drum for safety

D Type Double Gear & Double Pawl

ITEM	CAPACITY	CABLE	HOOK	Thickness		PACKING (Color Box)			
				Handle	Body	N.W. (KG)	G.W. (KG)	CUFT	Q'TY
HP-123D	2.5 TON	5mm x 10ft	2	3.5mm	3.5mm	24.6	25.3	1.75	6
HP-148D	4 TON	6mm x 10ft	3	5mm	6mm	22.9	23.5	1.38	3

Package : color box and blow case are available

Professional



Easy Operation



Safety



Durable



HAND POWER PULLER



DURABLE SOLID STEEL GEAR



3 HOOK

Strong, durable and easy operation

Durable solid steel gear construction for greater pulling power & safety

Large drop forged alloy steel safety hooks

Attractive bi-colored grip

Cable clamp fixed onto the drum for safety

D Type Single Gear & Single Pawl

ITEM	CAPACITY	CABLE	HOOK	Thickness		PACKING (Color Box)			
				Handle	Body	N.W. (KG)	G.W. (KG)	CUFT	QTY
HP-117D	2 TON	5mm x 12ft	2	3.5mm	3.5mm	23.5	24.2	1.75	6
HP-141D	4 TON	6mm x 12ft	3	5mm	6mm	21.5	22.2	1.38	3
HP-142D	4 TON	6mm x 12ft	2	5mm	6mm	20	20.6	1.38	3

Package : color box and blow case are available

Professional



Safety



Durable



Switch



HAND POWER PULLER



DURABLE SOLID STEEL GEAR

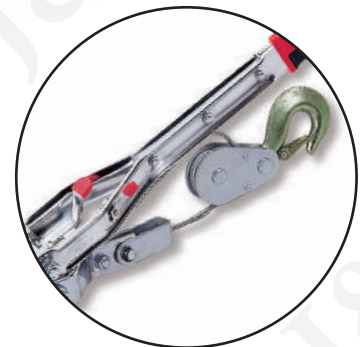

2 HOOK

Strong, durable and easy operation

Durable solid steel gear construction for greater pulling power & safety

Large drop forged alloy steel safety hooks

Attractive bi-colored grip

Cable clamp fixed onto the drum for safety

AI Type with Switch Double Gear & Double Pawl

ITEM	CAPACITY	CABLE	HOOK	Thickness		PACKING (Color Box)			
				Handle	Body	N.W. (KG)	G.W. (KG)	CUFT	Q'TY
HP-121D	2.5 TON	5mm x 10ft	2	3.5mm	3.5mm	24.6	25.3	1.75	6
HP-147D	4 TON	6mm x 10ft	3	5mm	6mm	22.9	23.5	1.38	3

Package : color box and blow case are available

Professional



Safety



Durable



Switch



HAND POWER PULLER

Strong, durable and easy operation

The new lightweight yet powerful hand power puller provides high strength but weight just 4.3 kg.

AI Type with Switch Double Gear & Double Pawl

ITEM	CAPACITY	CABLE	HOOK	Thickness		PACKING (Color Box)			
				Handle	Body	N.W. (KG)	G.W. (KG)	CUFT	Q'TY
HP-161D	4 TON	6mm x 8ft	2	3.5mm	3.5mm	19.2	20.5	1.36	4

Package : color box and blow case are available

Webbing Puller **Protect your cargo without scratching !**



Anti-rusted Insulation



Equilibrium

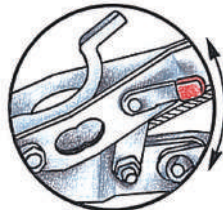

Switch



HAND POWER PULLER

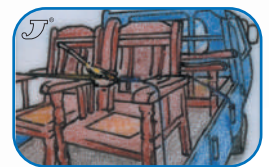

Transportation

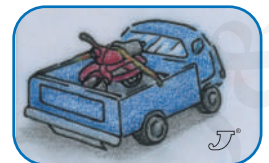

Leisure



Emergency

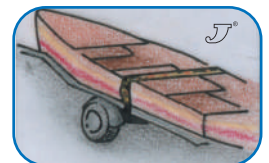

Boating

Your best partner & helpmate of labor-saving

It's a simple, but labor saving device designed based on the physical principles to help generate maximum pulling force by minimum force.

It's compact and light-weighted that make the puller easy to operate and carry. Applying to soft webbing instead of wires makes it possible to extend as much the length as needed.

Better fixation for the fragile surface cargo.

Non-conductive, Corrosion resistance and high strength strap.

Standard Type with Switch

ITEM	CAPACITY	WEBBING	GEAR / PAWL	HOOK	Thickness		PACKING			
					Handle	Body	N.W. (KG)	G.W. (KG)	CUFT	Q'TY
HPW-211	2 TON	25mm x 6m/9m	DOUBLE	2	3.5mm	3.5mm	19.5	21.5	1.95	6

Package : 1pc / color box

Rope Puller **Powerful tool for hauling and protecting cargo !**



Polyester rope with high tensile strength



Special ditch construction fitted with rope tightly



An innovation to prevent Hand Power Puller from tangle

- Great for boat yards, motorcycles, home, etc.
- Easy operation
- Unlimited reach
- Durable and Strong
- Equipped with non-conductive Polyester rope
- Polyester rope prevents object's surface from damaging or scraping
- Ergonomic and light weight construction
- Easy to carry and store

ITEM	CAPACITY	ROPE	GEAR / PAWL	HANDLE TYPE	HOOK	Thickness		PACKING			
						Handle	Body	N.W. (KG)	G.W. (KG)	CUFT	Q'TY
HPR-301	1 TON	∅ 10mm x 6m/9m	DOUBLE	STANDARD	3	3mm	3mm	18	19	1.1	6

Package : 1pc / color box



Transportation

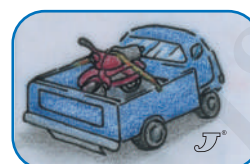

Leisure



Emergency

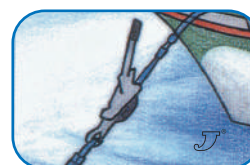

Boating

Rope Puller Powerful tool for hauling and protecting cargo !

HAND POWER PULLER



Light Handle

Light can be used individually



Black Handle



Bi-color Handle



Polyester rope with high tensile strength



Special ditch construction fitted with rope tightly



An innovation to prevent Hand Power Puller from tangle

- Great for boat yards, motorcycles, home, etc.
- Easy operation
- Unlimited reach
- Durable and Strong
- Equipped with non-conductive Polyester rope
- Polyester rope prevents object's surface from damaging or scraping
- Ergonomic and light weight construction
- Easy to carry and store

Ergonomic detachable handle design : 1. Bi-color
2. With separable emergency light

ITEM	CAPACITY	ROPE	GEAR PAWL	HANDLE TYPE	HOOK	Thickness		PACKING (Color Box)			
						Handle	Body	N.W. (KG)	G.W. (KG)	CUFT	QTY
HPR-302-1	1 TON	Ø 10mm x 6m/9m	DOUBLE	Black	3	Ø19x3mm	3mm	15	16	1.1	6
HPR-302-2	1 TON	Ø 10mm x 6m/9m	DOUBLE	Bi-Color	3	Ø19x3mm	3mm	15	16	1.1	6
HPR-302-3	1 TON	Ø 10mm x 6m/9m	DOUBLE	With Light	3	Ø19x3mm	3mm	15.5	17.5	1.1	6

Package : color box and blow case are available



Transportation

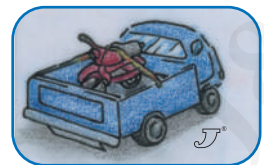

Leisure



Gardening



Fence

Portable Puller **Big puller in a little case !**



Light Handle

Light can be used individually



Black Handle



Bi-color Handle



HP-101PB



HAND POWER PULLER

Store easily under a pick-up seat or straps in a luggage carrier

Ergonomic detachable handle design

Emergency situations:

As a winch, move, immobilize, tow, rescue your vehicle in slopes, hollows, slippery terrain: snow covered, sandy or muddy road

Patents pending in USA, Canada, China and Taiwan

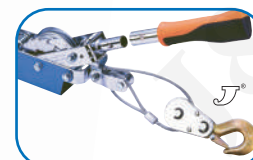

Easy assembly handle



Emergency



Fence

ITEM	CAPACITY	Cable	GEAR PAWL	HANDLE TYPE	HOOK	Thickness		PACKING			
						Handle	Body	N.W. (KG)	G.W. (KG)	CUFT	Q'TY
HP-101P-1	1 TON	5mm x 10'	Single	Black	2	3.5mm	3mm	20	21	1.96	6
HP-101P-2	1 TON	5mm x 10'	Single	Bi-Color	2	3.5mm	3mm	20	21	1.96	6
HP-101P-3	1 TON	5mm x 10'	Single	With Light	2	3.5mm	3mm	20	21	1.96	6
HP-101PB-1	1 TON	4mm x 6'	Single	Black	2	3.5mm	3mm	20	21	1.96	6
HP-101PB-2	1 TON	4mm x 6'	Single	Bi-Color	2	3.5mm	3mm	20	21	1.96	6
HP-101PB-2	1 TON	4mm x 6'	Single	With Light	2	3.5mm	3mm	20	21	1.96	6

Package : 1 set / blow case

Tow Strap



TS-5013HP



TS-5030DJ



TS-5030W



TS-7530W



TS-5003DW

2" TOW STRAP

ITEM NO.	(W) x (L)	BREAKING CAP.		
		4000 kgs	5000 kgs	6000 kgs
TS-5003	2" x 1m	W/HP/DJ	W/HP/DJ	W/HP
TS-5006	2" x 2m	W/HP/DJ	W/HP/DJ	W/HP
TS-5010	2" x 3m	W/HP/DJ	W/HP/DJ	W/HP
TS-5013	2" x 4m	W/HP/DJ	W/HP/DJ	W/HP
TS-5016	2" x 5m	W/HP/DJ	W/HP/DJ	W/HP
TS-5020	2" x 6m	W/HP/DJ	W/HP/DJ	W/HP
TS-5023	2" x 7m	W/HP/DJ	W/HP/DJ	W/HP
TS-5026	2" x 8m	W/HP/DJ	W/HP/DJ	W/HP
TS-5030	2" x 9m	W/HP/DJ	W/HP/DJ	W/HP
TS-5033	2" x 10m	W/HP/DJ	W/HP/DJ	W/HP

2" DOUBLE LAYERS TOW STRAP

ITEM NO.	DESCRIPTION	BREAKING CAP.	
		7000 (kgs)	PACK
TS-5003DW	2" x 1m	w	PVC Bag / Double Blister
TS-5006DW	2" x 2m	w	PVC Bag / Double Blister
TS-5010DW	2" x 3m	w	PVC Bag / Double Blister
TS-5013DW	2" x 4m	w	PVC Bag / Double Blister
TS-5016DW	2" x 5m	w	PVC Bag / Double Blister
TS-5020DW	2" x 6m	w	PVC Bag / Double Blister
TS-5023DW	2" x 7m	w	PVC Bag / Double Blister
TS-5026DW	2" x 8m	w	PVC Bag / Double Blister
TS-5030DW	2" x 9m	w	PVC Bag / Double Blister
TS-5033DW	2" x 10m	w	PVC Bag / Double Blister

3" TOW STRAP

ITEM NO.	DESCRIPTION	BREAKING CAP.	
		7000 (kgs)	PACK
TS-7506W	3" x 2m	w	PVC Bag / Double Blister
TS-7510W	3" x 3m	w	PVC Bag / Double Blister
TS-7513W	3" x 4m	w	PVC Bag / Double Blister
TS-7516W	3" x 5m	w	PVC Bag / Double Blister
TS-7520W	3" x 6m	w	PVC Bag / Double Blister
TS-7523W	3" x 7m	w	PVC Bag / Double Blister
TS-7526W	3" x 8m	w	PVC Bag / Double Blister
TS-7530W	3" x 9m	w	PVC Bag / Double Blister
TS-7533W	3" x 10m	w	PVC Bag / Double Blister

Remark : 1,the abbreviation above mean the separate end-fitting attached to the tow strap,the details will be as following (please choose one end-fitting only as your product):

- W** -2 Sewn loops
- HP** -2 "HP" hooks
- DJ** -2 "DJ" hooks

2.**PVC bag** package.

Wire Tow Cable



5CAH-12/20
6CAH-12/20
8CAH-12/20



5CAP-12/20
6CAP-12/20
8CAP-12/20



5CAH-12HP/20HP
6CAH-12HP/20HP
8CAH-12HP/20HP



5CAP-12U/20U
6CAP-12U/20U
8CAP-12U/20U

ITEM NO.	DESCRIPTION	PACKAGE	N.W.(KG)	G.W.(KG)	CUFT	Q'TY
5CAH-12	5mm x 12ft W/O HOOK	Sliding card	6.0	8.0	1.45'	15
5CAH-12HP	5mm x 12ft W/2 HOOK	Sliding card	12.0	14.0	1.45'	15
5CAH-20	5mm x 20ft W/O HOOK	Sliding card	10.0	12.0	1.45'	15
5CAH-20HP	5mm x 20ft W/2 HOOK	Sliding card	16.0	18.0	1.45'	15
6CAH-12	6mm x 12ft W/O HOOK	Sliding card	8.5	10.5	1.45'	15
6CAH-12HP	6mm x 12ft W/2 HOOK	Sliding card	17.5	19.5	1.45'	15
6CAH-20	6mm x 20ft W/O HOOK	polybag	26.7	28.2	1.20'	30
6CAH-20HP	6mm x 20ft W/2HOOK	polybag	29.8	31.5	1.20'	20
8CAH-12	8mm x 12ft W/O HOOK	Sliding card	13.5	15.5	1.45'	15
8CAH-12HP	8mm x 12ft W/2HOOK	Sliding card	26.0	28.0	1.45'	15
8CAH-20	8mm x 20ft W/O HOOK	polybag	27.8	29.3	1.40'	20
8CAH-20HP	8mm x 20ft W/2 HOOK	polybag	22.0	23.5	1.40'	10

